

# Product Information

## FIDENART-AD - Adventure Art Den

BS EN 1176 - Designed to British & European Standards

### MATERIALS

**Panels** - Two Colour  High Density Polyethylene (HDPE)

**Posts** - Extruded aluminium post with powder coat finish

### SUPPLY METHOD

Pre-assembled items: Roof, Benches, Panels, Mini Posts



### DIMENSIONS

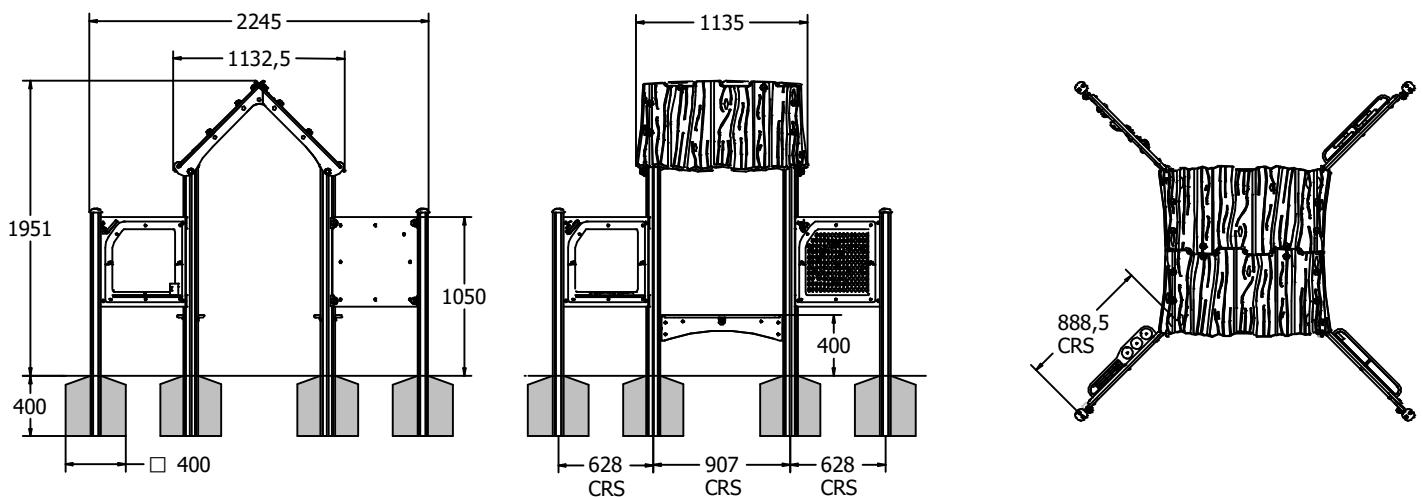

### TECHNICAL

**Age Range:** 2+ Years  
**Largest Part:** Tall Aluminium Post: 100 x 100 x 1785mm  
**Heaviest Part:** Adventure Apex Roof Half - 13.2kg  
**Total Weight:** 102kg Approx.  
**Surfacing:** N/A







IMPORTANT: you must specify the colour option you require at the time of order if it is different from the colour listed/shown above, requirements are subject to availability at the time of order

# Product Information

## FIDENART-AD - Adventure Art Den



### FEATURES

-  **WINDOW** - Clear polycarbonate window
-  **INCLUSIVE** - Panels positioned at accessible height
-  **DRAW** - Dry Wipe and Chalk Panels for creative play
-  **SOCIAL** - Seating encourages interaction between children
-  **VISUAL** - Create patterns along the weave panel
-  **PAINT** - Painting Panel with pots and brushes

IMPORTANT: you must specify the colour option you require at the time of order if it is different from the colour listed/shown above, requirements are subject to availability at the time of order