

Product Information

FITMRE2RG – 2 Player RotoGen Reactions Totem

BS EN 1176 - Designed to British & European Standards

MATERIALS

Panel - Two Colour  High Density Polyethylene (HDPE)

Beam Edge - Extruded aluminium with powder coat finish

Windows - Shatterproof Polycarbonate

SUPPLY METHOD

Totem - Fully assembled

FEATURES:

 **ROTOGEN** - Human powered energy for electronics

 **REACTIONS** - Multiplayer speed based reaction gameplay

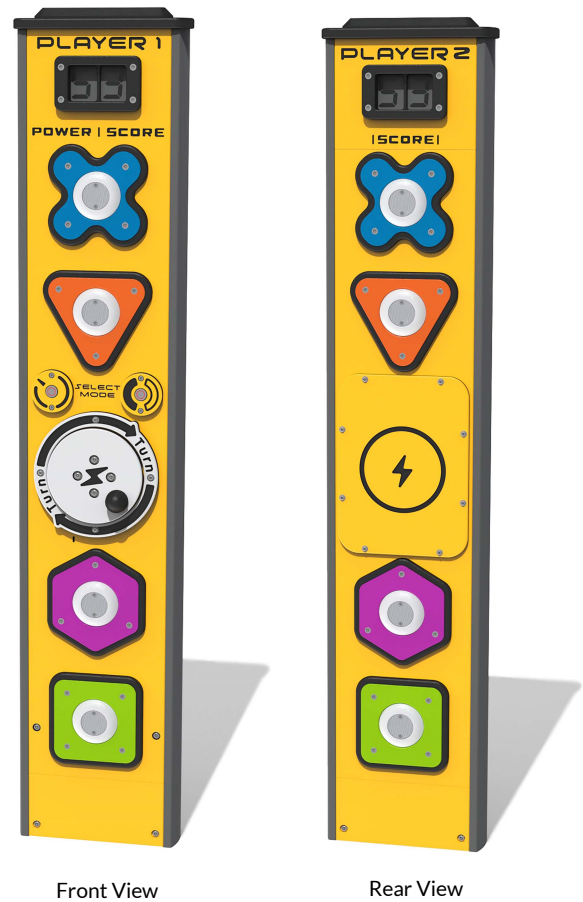

Front View

Rear View

DIMENSIONS

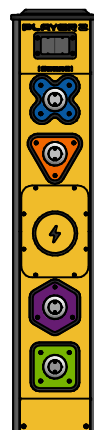
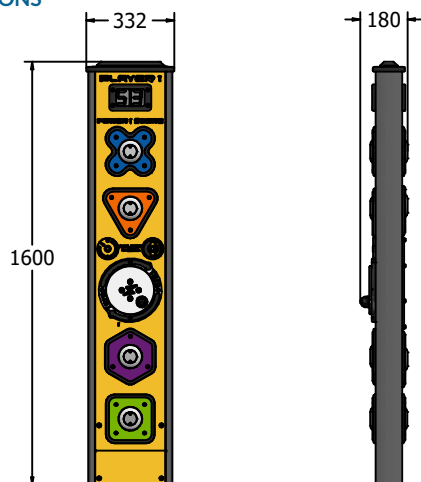

Foundation Detail:

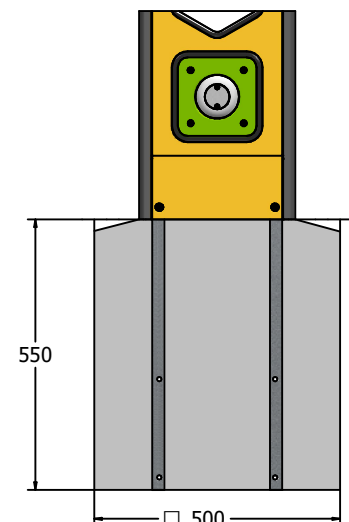

TECHNICAL

Age Range: 2+ Years
 Largest Part: FITMRE2RG - 1600 x 332 x 180mm
 Total Weight: FITMRE2RG - 30.5kg
 Surfacing: N/A

IMPORTANT: you must specify the colour option you require at the time of order if it is different from the colour listed/shown above, requirements are subject to availability at the time of order