

# Product Information

## FIASATW - Art Station - Weave

BS EN 1176 - Designed to British & European Standards

### MATERIALS

**Panels** - Two Colour High Density Polyethylene (HDPE)

**Post** - Extruded aluminium post with powder coat finish

### SUPPLY METHOD

**Panels** - Pre-assembled

**Post** - Supplied with T-slot stops & post cap

**Pens, Chalks & Rope** - Boxed separately



## DIMENSIONS

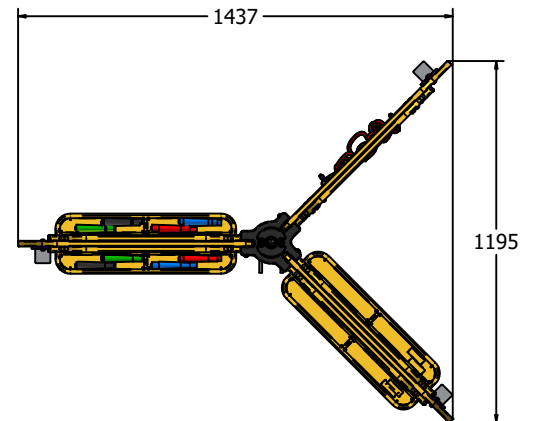
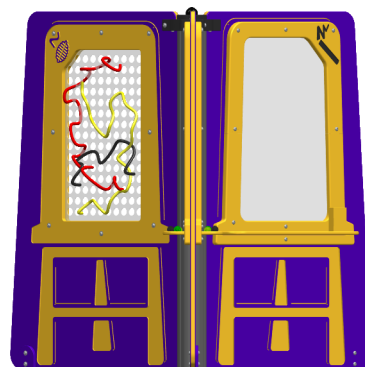
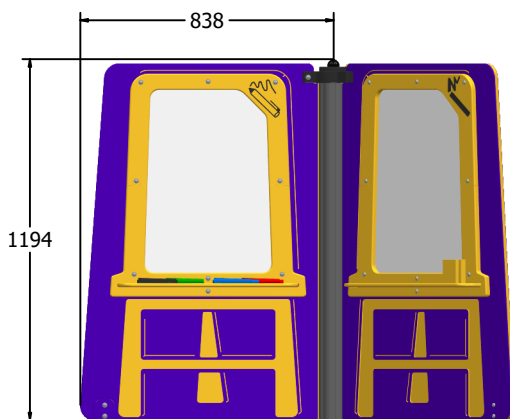

## TECHNICAL

**Age Range:** 2+ Years  
**Largest Part:** FIASATW - 1194 x 1437x 1195mm  
**Total Weight:** FIASATW - 70kg  
**Surfacing:** N/A

IMPORTANT: you must specify the colour option you require at the time of order if it is different from the colour listed/shown above, requirements are subject to availability at the time of order



## Product Information

### FIASATW - Art Station Weave

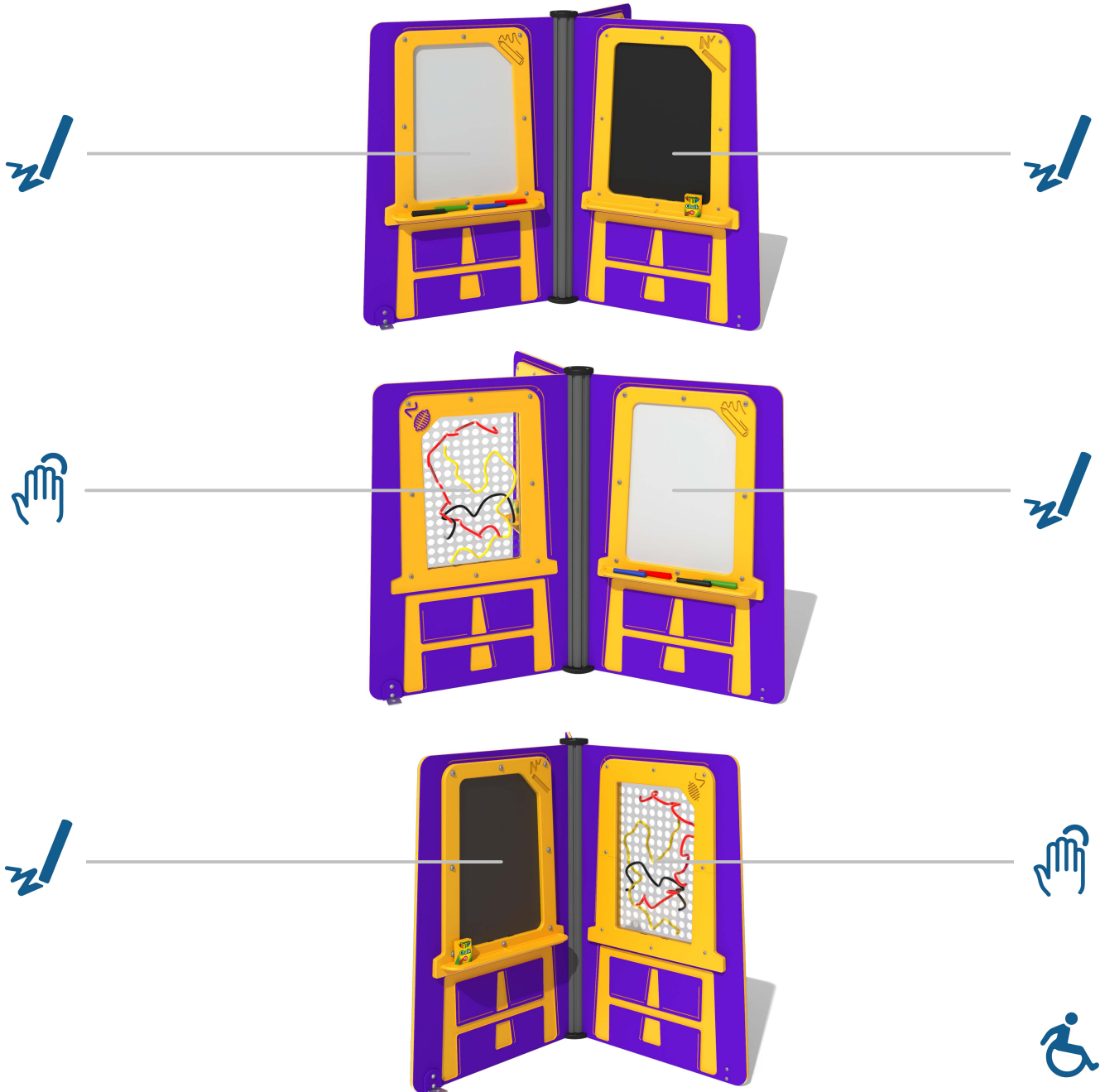
---



#### FEATURES

-  **DRAW** - Dry wipe and chalkboard activities
-  **TOUCH** - Double-sided weaving activity
-  **INCLUSIVE** - Activities positioned at easily accessible heights

IMPORTANT: you must specify the colour option you require at the time of order if it is different from the colour listed/shown above, requirements are subject to availability at the time of order