

Product Information

FIMU5FLATLOWIN - Pentatonic Flat Chimes Musical Panel Insert

BS EN 1176 - Designed to British & European Standards

MATERIALS

Panel - Two Colour High Density Polyethylene (HDPE)

Flat Chimes - Anodised aluminium with a brushed finish

SUPPLY METHOD

Insert - Fully assembled

FEATURES



INCLUSIVE - Chimes positioned at easily accessible height



MUSICAL - Set of 5 musically tuned chimes



Insert can easily attach to your own panel



Rear view of insert attached to host panel



DIMENSIONS

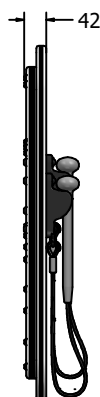
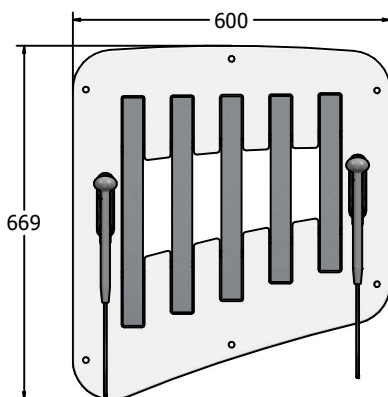

Host panel fixing detail

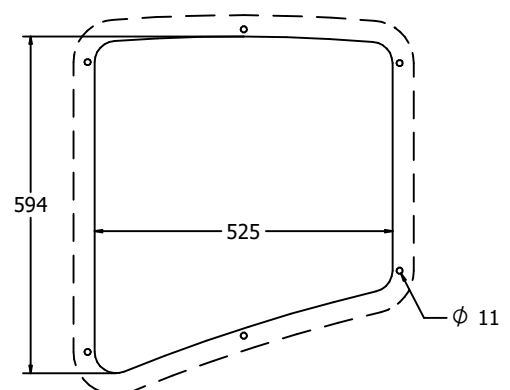

CAD available on request

TECHNICAL

Age Range: 2+ Years
 Largest Part: 600 x 669 x 116mm
 Total Weight: 10kg
 Surfacing: N/A

IMPORTANT: you must specify the colour option you require at the time of order if it is different from the colour listed/shown above, requirements are subject to availability at the time of order